

## SECTION VIEW

### T52/26 SELF-DRILLING ANCHOR PROPERTIES

- AREA: 1.92 SQ. INCHES
- YIELD LOAD: 164.4 KIP
- YIELD STRESS: 85.7 KSI
- WEIGHT: 6.53 LB/FT

### NOTES:

- TESTED IN ACCORDANCE WITH ASTM A370-14
- TESTED IN ACCORDANCE WITH ASTM E415-14

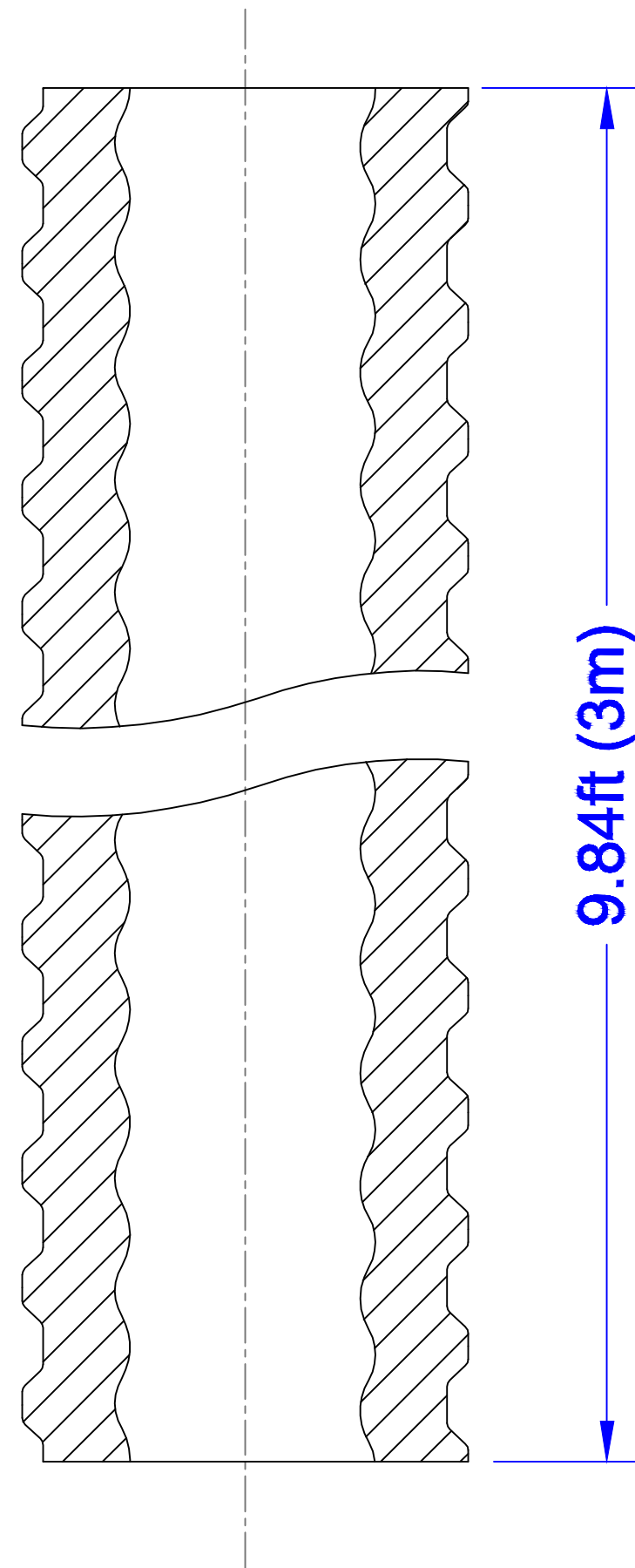

**MAGNACORE**<sup>®</sup>  
SELF-DRILLING  
ANCHORS

THE INFORMATION CONTAINED HEREIN IS OF A PROPRIETARY NATURE AND IS SUBMITTED IN CONFIDENCE FOR USE OF THE CLIENTS OF INTECH ANCHORING SYSTEMS

#### Issue / Revisions:

Rev	Description	Date

SHEET TITLE: MAGNACORE SPECS

SHEET DESCRIPTION: T52-26 Bar

DATE: 07/22/2020

DRAWN BY: SJP

CHECKED BY: JMC

SHEET:

**BAR**